

Varenummer: 4320000901
Beskrivelse: Rota-fix spændelement A 90x130
Rustfast stål

Mål

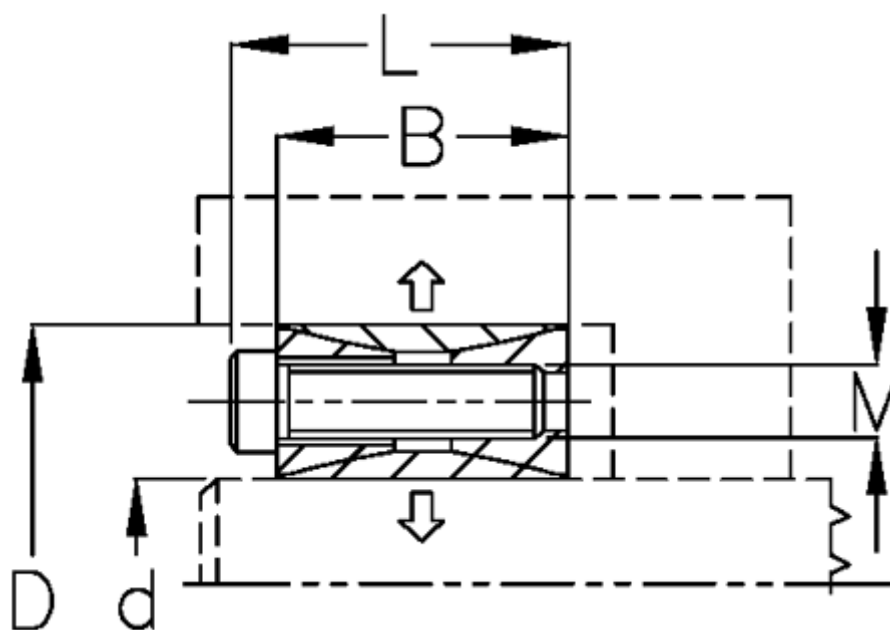

B mm	= 28
d H8 mm	= 90
D mm	= 130
F kN aksialkraft	= 94.9
L mm	= 38
M mm	= M10
Overfladeruhed	= R? ? 3.2 μ m
P N/mm ² fladetryk på aksel/nav	= 50

T Nm drejningsmoment	= 4200
Tolerance	= Aksel k11-h11, Nav M
Ts Nm boltetilspændingsmoment	= 44.0